



HANSCRAFT SAUNA PALAPELI (HS4|HSR4)

[CZ] návod k instalaci

[EN] installation instructions

[DE] installationsanweisungen

PALAPELI (HS4 | HSR4)

[CZ] OBSAH

1	BEZPEČNOSTNÍ POKYNY	3
2	POPIS	4
2.1	Obsah balení	4
2.2	Nástroje potřebné k instalaci	7
2.3	Specifikace	8
3	INSTALACE	9

[EN] CONTENT

1	SAFETY INSTRUCTIONS	3
2	DESCRIPTION	4
2.1	Package contents	4
2.2	Tools needed for installation	7
2.3	Specifications	8
3	INSTALLATION	9

[DE] INHALT

1	SICHERHEITSHINWEISE	4
2	BEZEICHNUNG	4
2.1	Packungsinhalt	4
2.2	Benötigte Werkzeuge für die Installation	7
2.3	Spezifikationen	8
3	INSTALLATION	9

1 [CZ] BEZPEČNOSTNÍ POKYNY

- Než začnete pracovat, zkontrolujte si, že balení obsahuje všechny díly dle kusovníku.
- Pro montáž potřebujete pomocníka.
- S tvrzeným sklem zacházejte opatrně. Vyvarujte se narážení z boku, tam je sklo nejnáchylnější k rozbití. Při montáži sklo opřete o karton, deku nebo jiný měkký povrch.
- Je nutné dodržet odstup od stěny min. 10 cm.
- Ujistěte se, že saunu instalujete na tepelně odolný povrch.
- Podlaha musí být rovná.
- Berte prosím na vědomí, že dřevo je přírodní materiál, který může v důsledku vlhkosti bobtnat, smršťovat se nebo deformovat.
- Dřevěné části, které se mají používat uvnitř, nesmí být ošetřeny žádným chemickým přípravkem nebo impregnačním činidlem.
- Pravidelně kontrolujte, zda jsou všechna kování řádně utažená a v případě potřeby dotáhněte.

1 [EN] SAFETY INSTRUCTIONS

- Before you start working, make sure that the package contains all the parts according to the list.
- You will need a helpmate for the installation.
- Handle tempered glass carefully. Avoid hitting the side where the glass is most prone to breakage. During assembly, rest the glass on a cardboard, blanket or other soft surface.
- It is necessary to keep the distance at least 10 cm from the wall.
- Make sure you install the sauna on a heat-resistant surface.
- The floor must be level.
- Please mind that wood is a natural material that can swell, shrink, or deform due to moisture.
- Wooden parts inside the sauna must not be treated with any chemical or impregnating agent.
- Check regularly that all fittings are properly tightened and tighten if necessary.

PALAPELI (HS4 | HSR4)

1 [DE] SICHERHEITSHINWEISE

- Bevor Sie mit der Arbeit beginnen, stellen Sie sicher, dass das Paket alle Teile enthält.
- Sie benötigen einen Helfer für die Installation.
- Gehen Sie vorsichtig mit dem gehärtetem Glas um. Vermeiden Sie ein seitliches Schlagen, da Glas am anfälligsten für Bruch ist. Legen Sie das Glas bei der Montage auf einen Karton, eine Decke oder eine andere weiche Oberfläche.
- Der Wandabstand muss mindestens 10 cm betragen.
- Stellen Sie sicher, dass Sie die Sauna auf einer hitzebeständigen Oberfläche installieren.
- Der Boden muss eben sein.
- Bitte beachten Sie, dass Holz ein natürliches Material ist, das durch Feuchtigkeit quellen, schrumpfen oder sich verformen kann.
- Holzteile für den Innenbereich dürfen nicht mit Chemikalien oder Imprägniermitteln behandelt werden.
- Überprüfen Sie regelmäßig, ob alle Verschraubungen richtig angezogen sind und ziehen Sie sie gegebenenfalls nach.

2 [CZ] POPIS [EN] DESCRIPTION [DE] BEZEICHNUNG

2.1 [CZ] Obsah balení [EN] Package contents [DE] Packungsinhalt

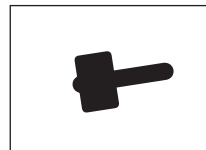
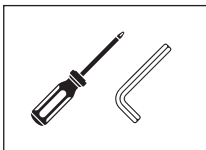

PALAPELI (HS4 | HSR4)

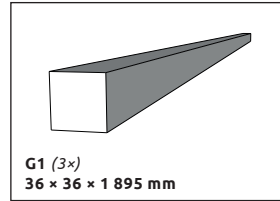
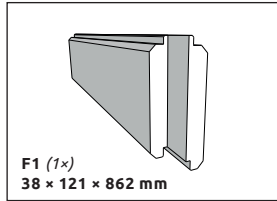
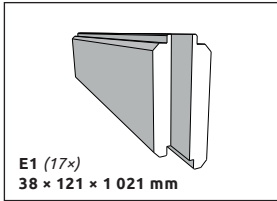
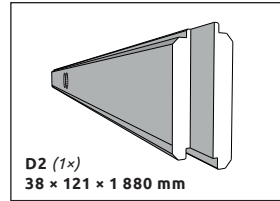
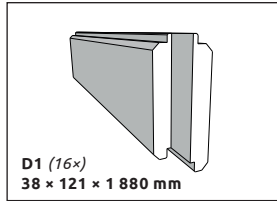
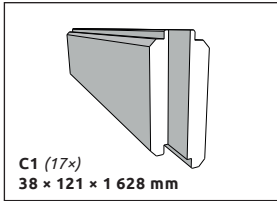
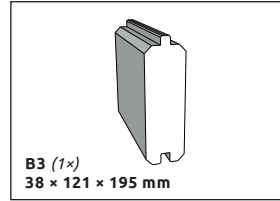
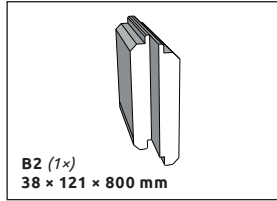
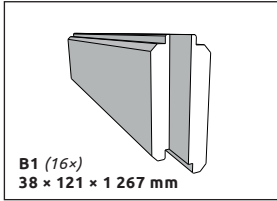
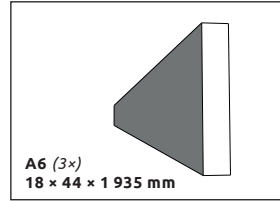
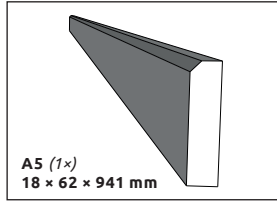
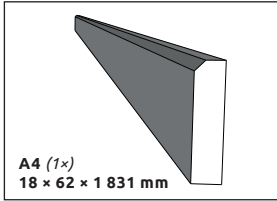
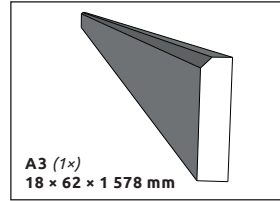
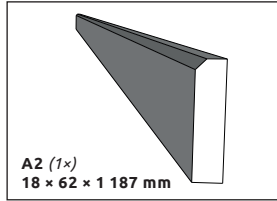
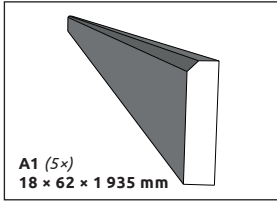
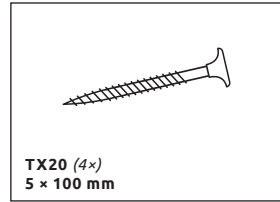
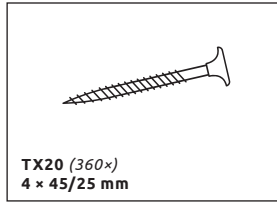
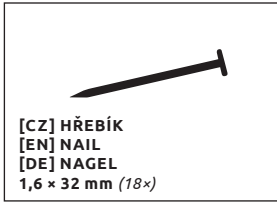

PALAPELI (HS4 | HSR4)

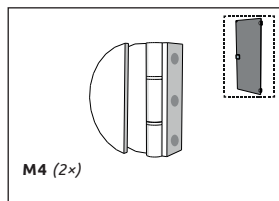
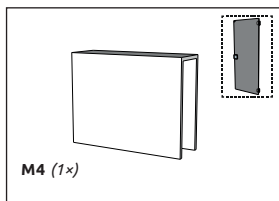
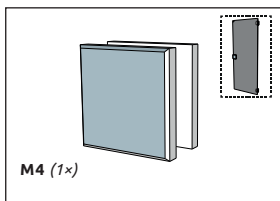
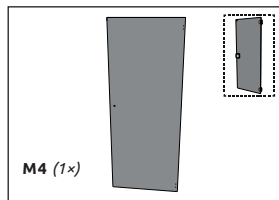
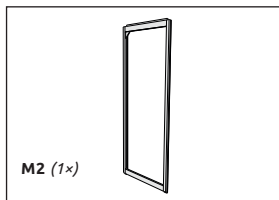
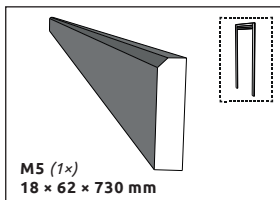
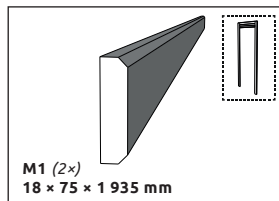
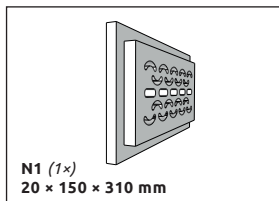
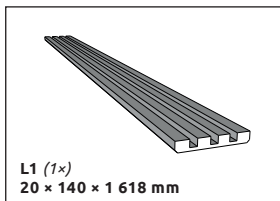
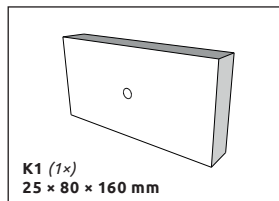
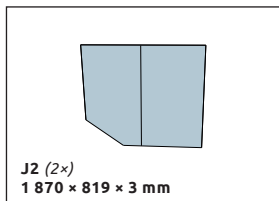
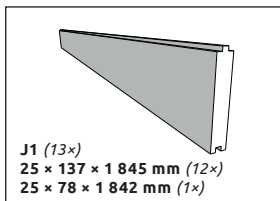
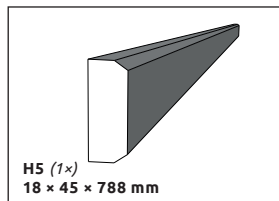
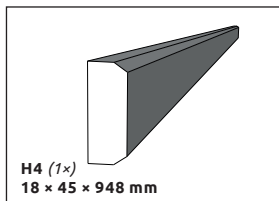
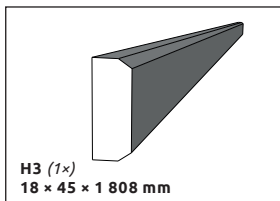
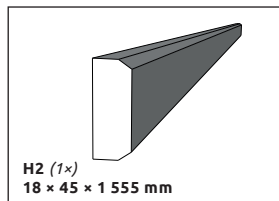
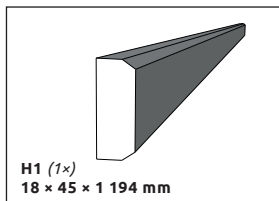
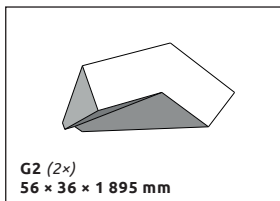

PALAPELI (HS4 | HSR4)

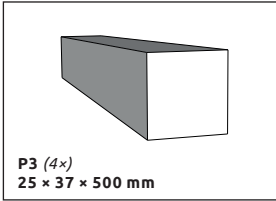
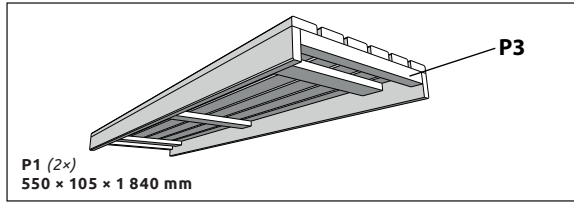
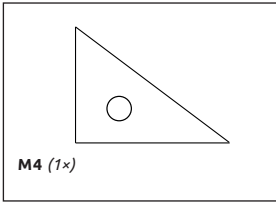

2.2 [CZ] Nástroje potřebné k instalaci (nejsou zahrnuty v balení)

[EN] Tools needed for installation
(not included in the package)

[DE] Benötigte Werkzeuge für die Installation
(nicht im Paket enthalten)

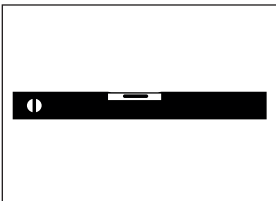

PALAPELI (HS4 | HSR4)

- 2.3 [CZ] Specifikace
- [EN] Specifications
- [DE] Spezifikationen

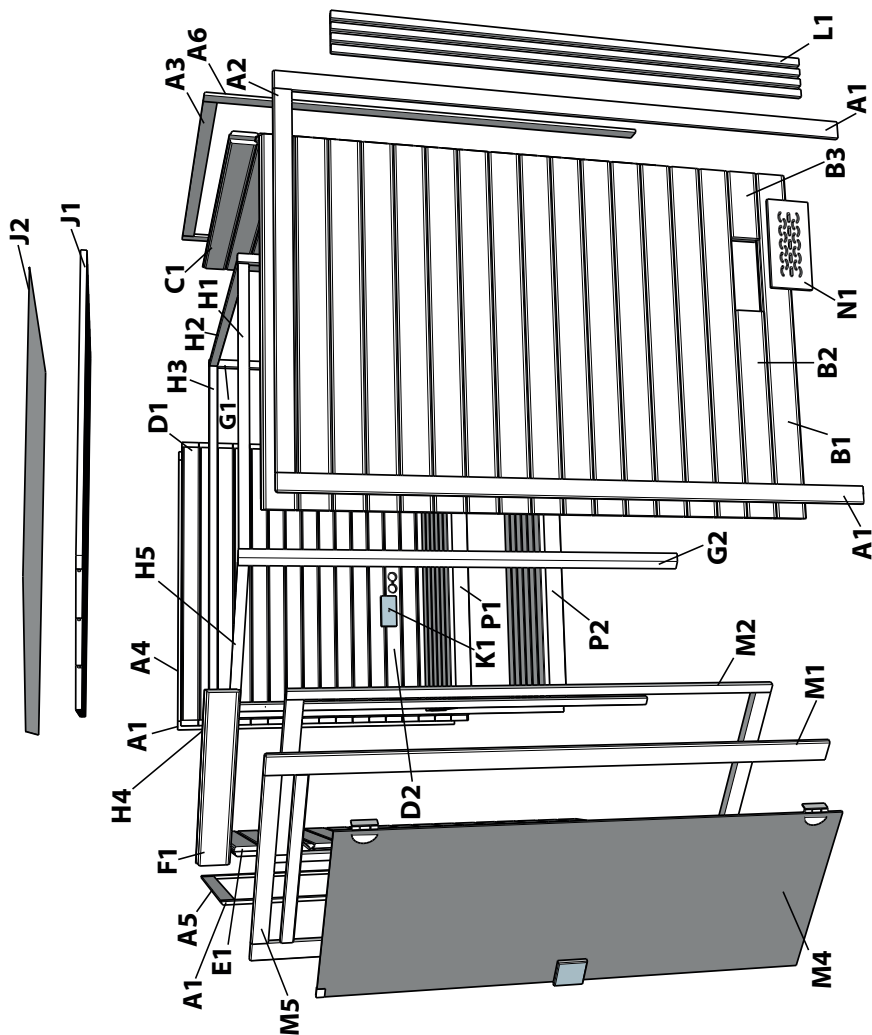

3 [CZ] INSTALACE [EN] DESCRIPTION [DE] BEZEICHNUNG

1)

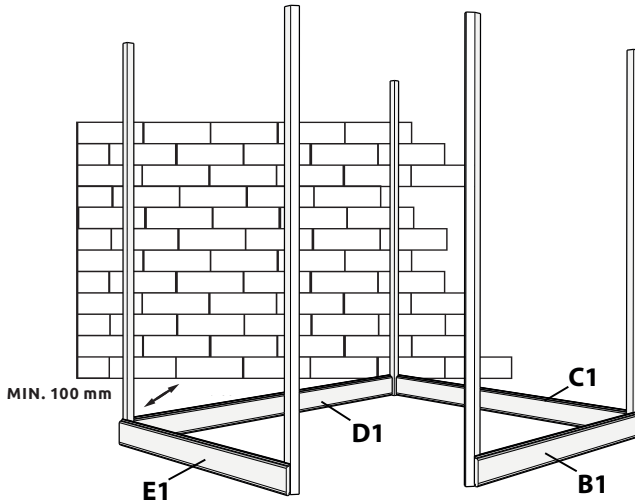

2)

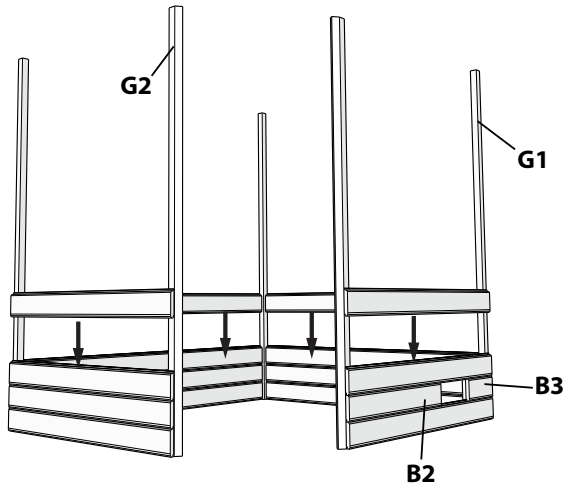

PALAPELI (HS4 | HSR4)

3)

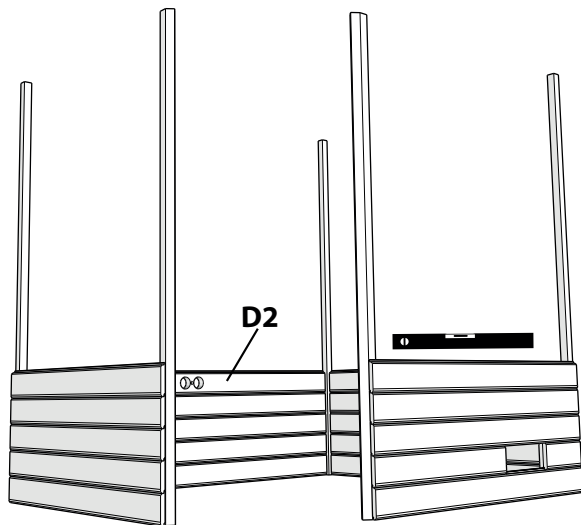

4)

F1

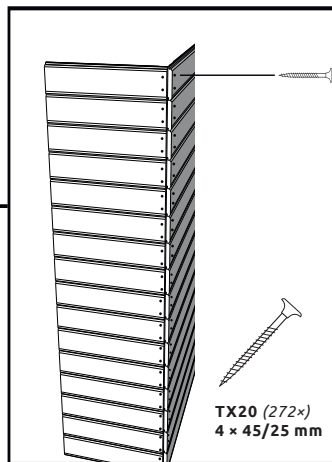
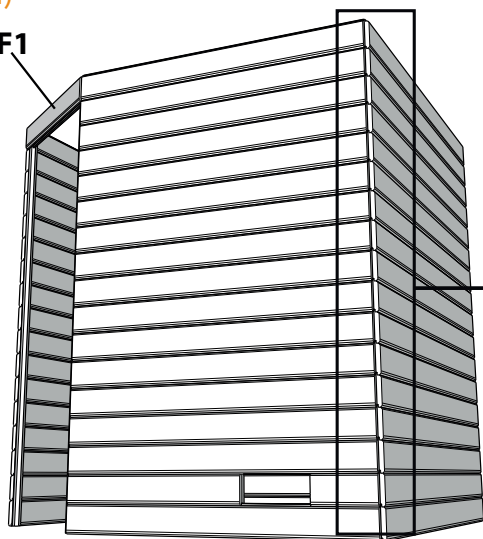

PALAPELI (HS4 | HSR4)

5)

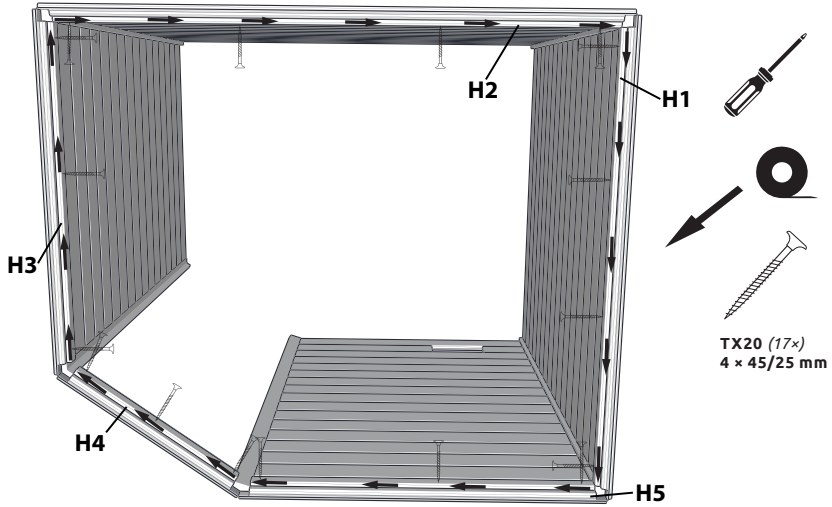

6)

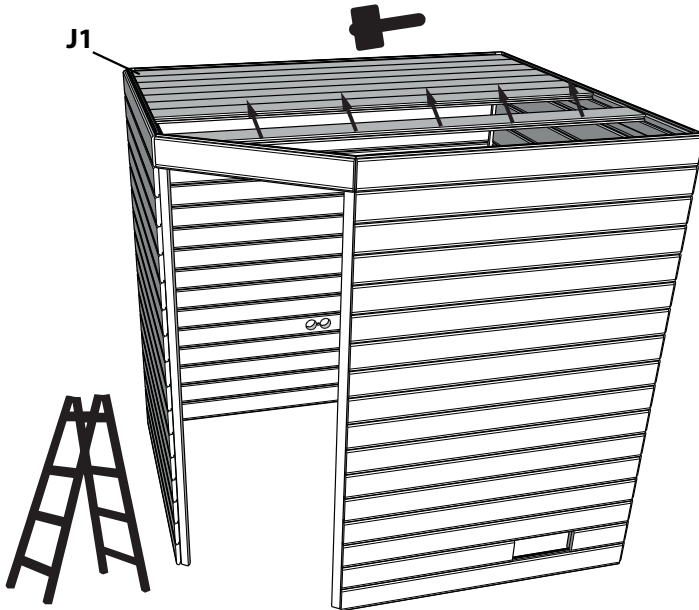

PALAPELI (HS4 | HSR4)

7)



8)

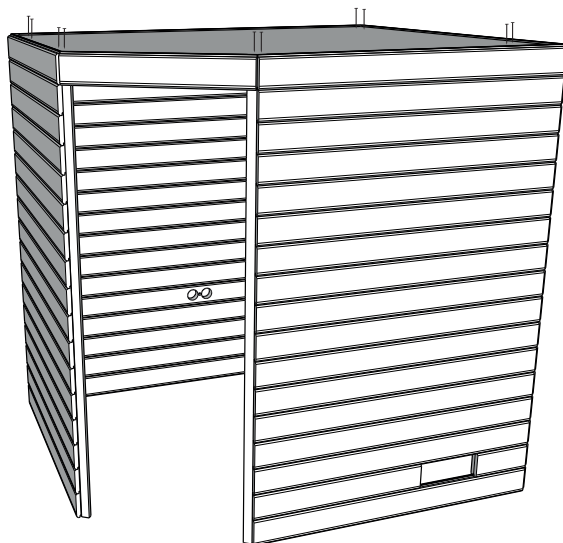

[CZ] HŘEBÍK
[EN] NAIL
[DE] NAGEL
1,6 x 32 mm
(10x)

PALAPELI (HS4 | HSR4)

9)

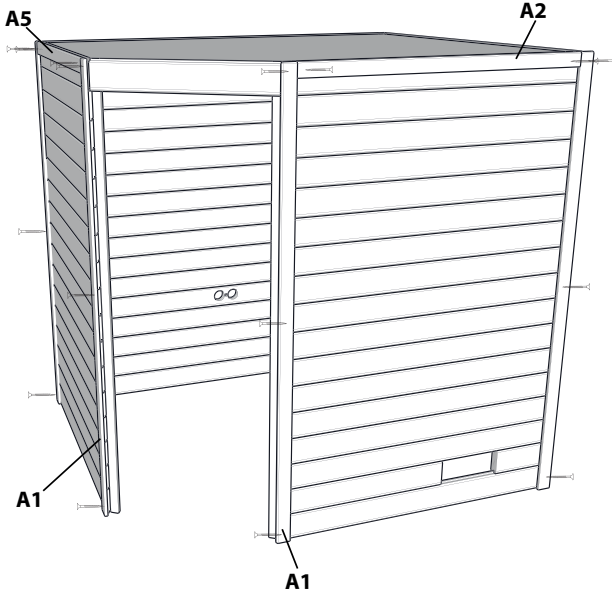

TX20 (16x)
4 x 45/25 mm

10)

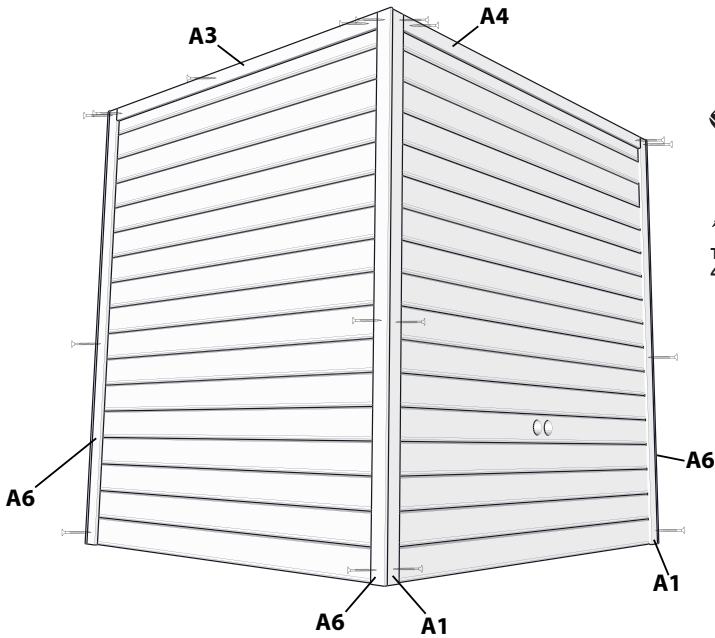

TX20 (16x)
4 x 45/25 mm

PALAPELI (HS4 | HSR4)

11)

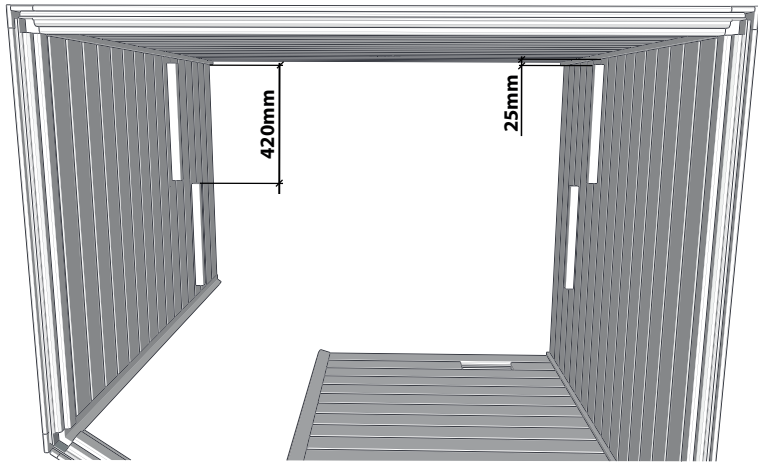

12)

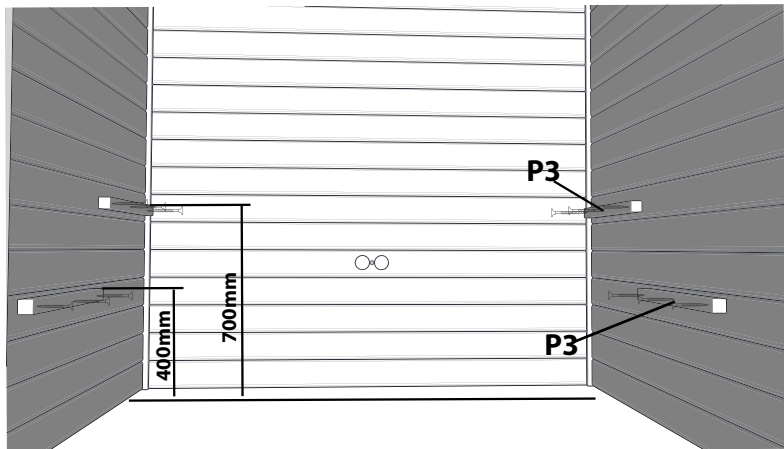

TX20 (12x)
4 x 45/25 mm

PALAPELI (HS4 | HSR4)

13)

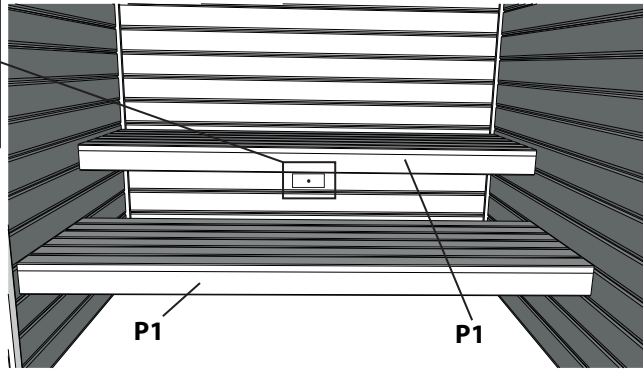
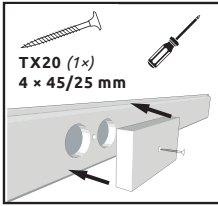

14)

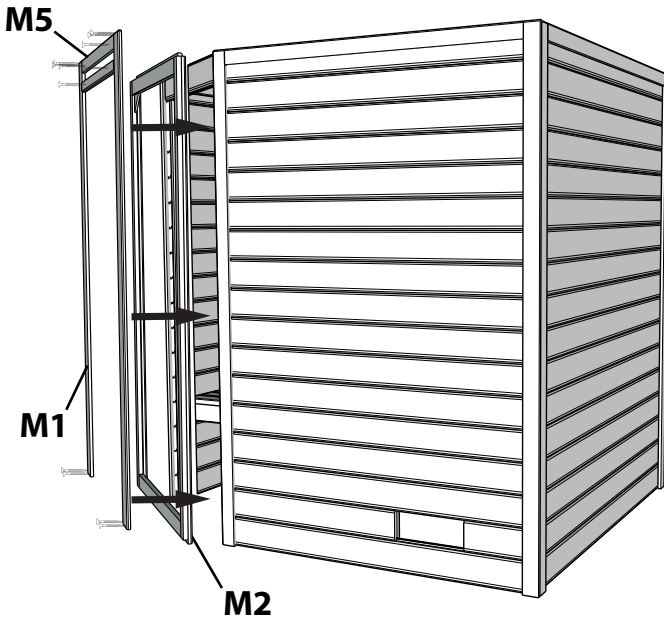

TX20 (12x)
4 × 45/25 mm

PALAPELI (HS4 | HSR4)

15)

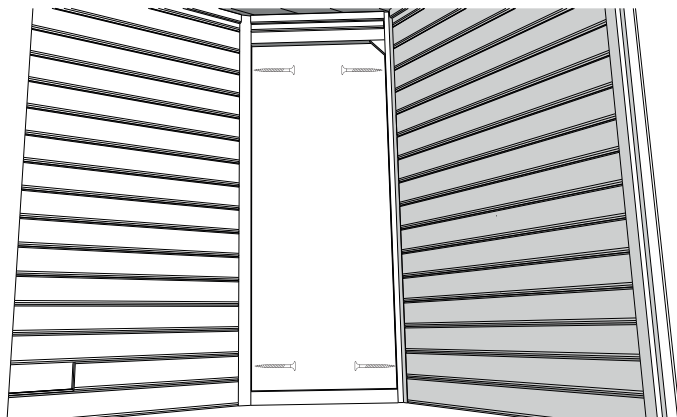

TX20 (4x)
5 × 100 mm

16)

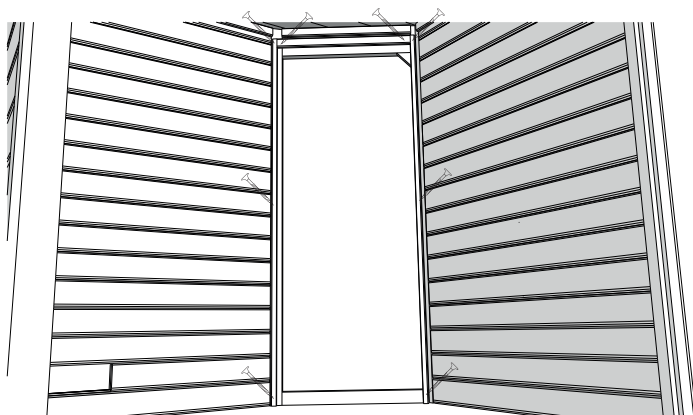

TX20 (8x)
4 × 45/25 mm

PALAPELI (HS4 | HSR4)

17)

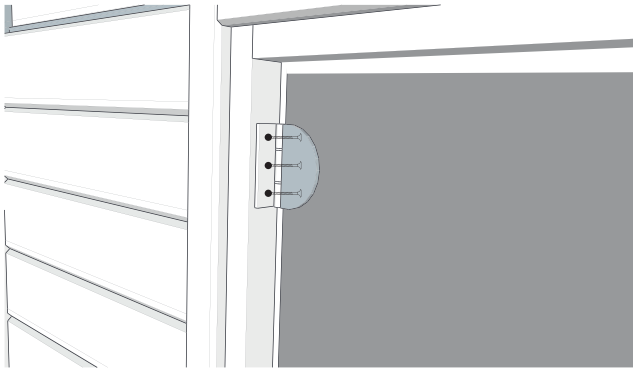

TX20 (3x)
4 × 45/25 mm

18)

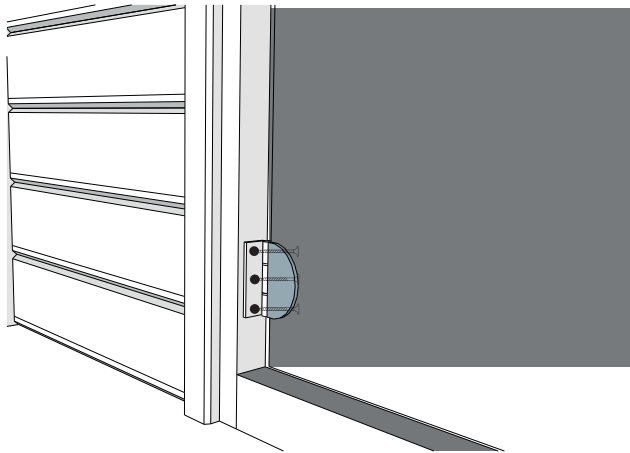

TX20 (3x)
4 × 45/25 mm

PALAPELI (HS4 | HSR4)

19)



20)



PALAPELI (HS4 | HSR4)

21)

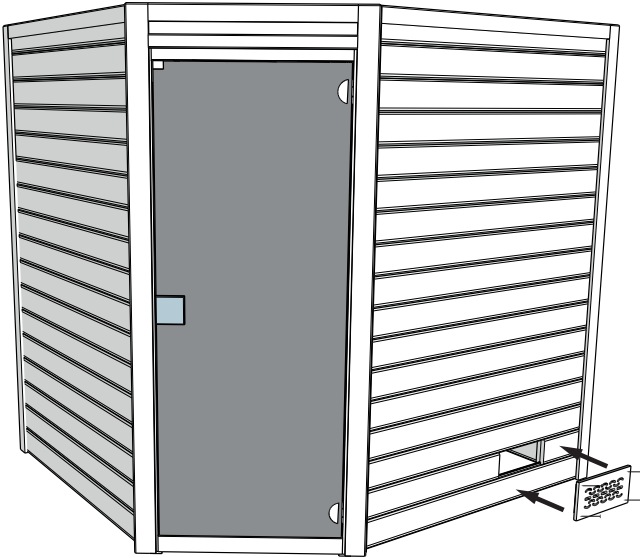

[CZ] HŘEBÍK
[EN] NAIL
[DE] NAGEL
1,6 x 32 mm
(4x)

22)

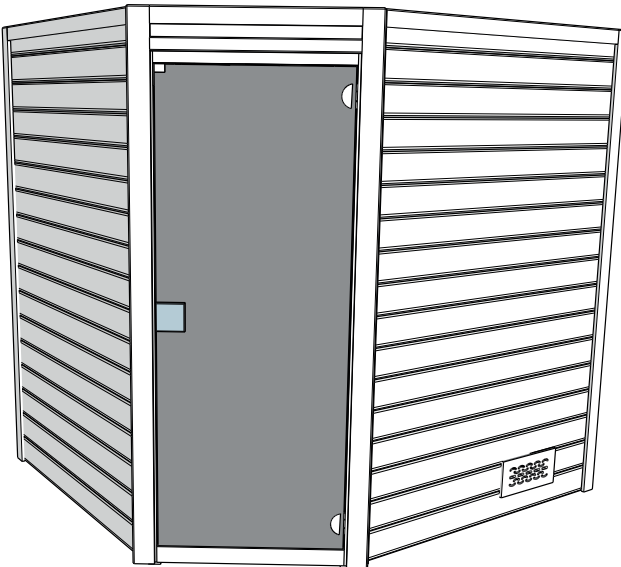

HANSCRAFT[®]
european spa producer

HANSCRAFT, s. r. o.

Bečovská 939

104 00 Praha 10-Uhřetíněves

CZECH REPUBLIC

www.HANSCRAFT.cz